



Introduction to Robotics

Lecture 12

Shuang Li, Jianwei Zhang
[sli, zhang]@informatik.uni-hamburg.de



University of Hamburg
Faculty of Mathematics, Informatics and Natural Sciences
Department of Informatics
Technical Aspects of Multimodal Systems

July 10, 2020



- Introduction
- Spatial Description and Transformations
- Forward Kinematics
- Robot Description
- Inverse Kinematics for Manipulators
- Instantaneous Kinematics
- Trajectory Generation 1
- Trajectory Generation 2
- Dynamics
- Robot Control
- Path Planning
- Task/Manipulation Planning
- Telerobotics
- Architectures of Sensor-based Intelligent Systems





- The CMAC-Model
- The Subsumption-Architecture
- Control Architecture of a Fish
- Procedural Reasoning System
- Hierarchy
- Architectures for Learning Robots

Summary

Conclusion and Outlook





Overview

- ▶ Basic behavior
- ▶ Behavior fusion
- ▶ Subsumption
- ▶ Hierarchical architectures
- ▶ Interactive architectures

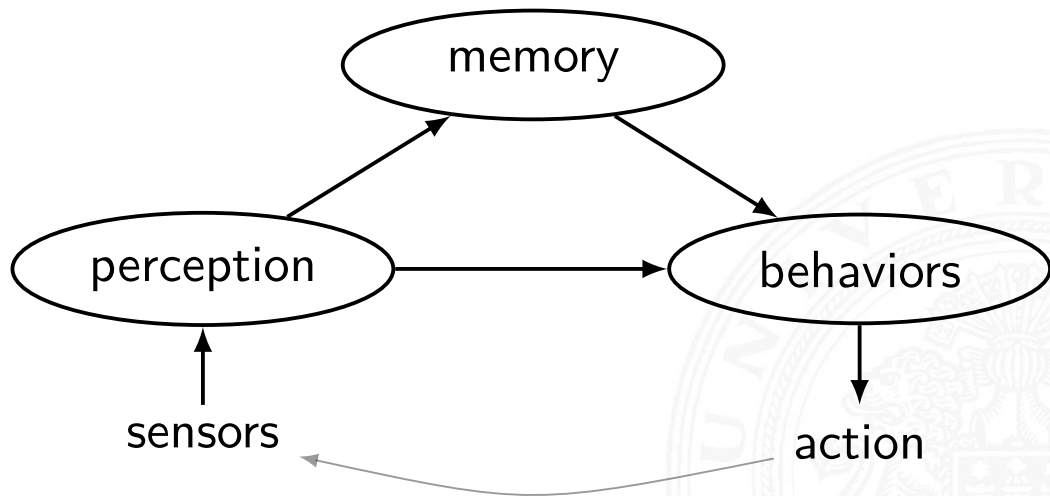



CMAC: Cerebellar Model Articulation Controller

S sensory input vectors (firing cell patterns)

A association vector (cell pattern combination)

P response output vector ($\mathbf{A} \cdot \mathbf{W}$)

W weight matrix

The CMAC model can be viewed as two mappings:

$$f : \mathbf{S} \rightarrow \mathbf{A}$$

$$g : \mathbf{A} \xrightarrow{\mathbf{W}} \mathbf{P}$$





CMAC-Model (cont.)

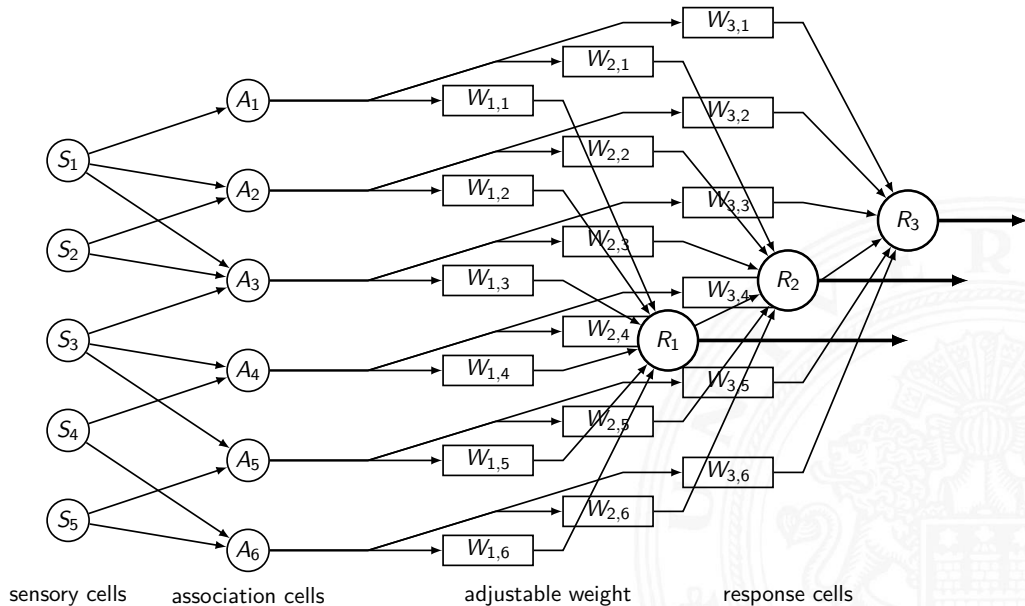

Artificial neural networks (ANN) or connectionist systems are computing systems vaguely inspired by the biological neural networks that constitute animal brains.

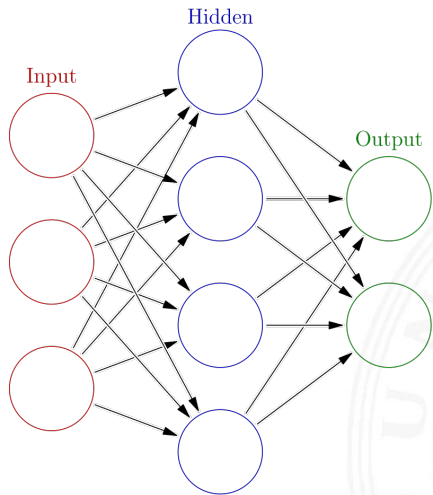

The Subsumption Architecture

- ▶ hierarchical structure of behavior
- ▶ higher level behaviors subsume lower level behaviors

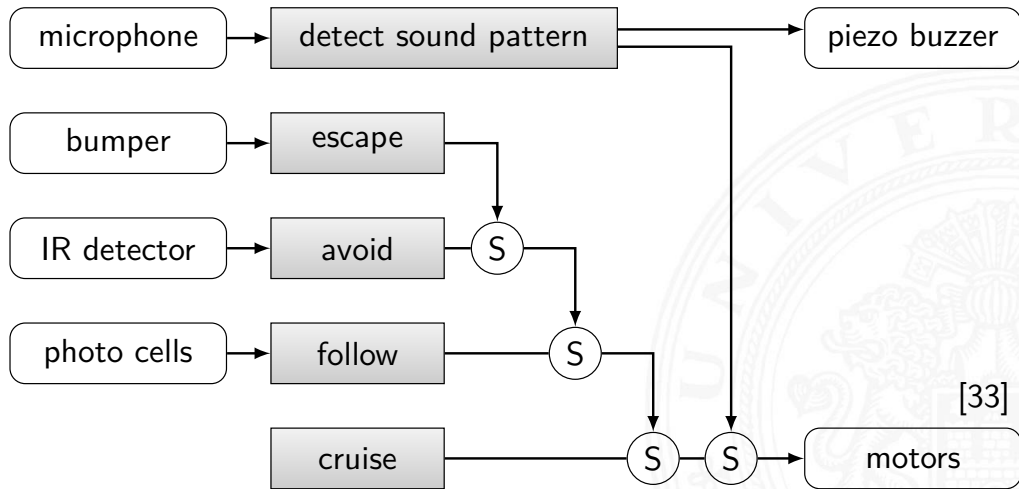

Foraging and Flocking

- ▶ multi-robot architecture
- ▶ basic behaviors are sequentially executed

flocking=wandering+aggregation+dispersion
surrounding=wandering+following+aggregation
herding=wandering+surrounding+flocking
foraging=wandering+dispersion+following
+homing+flocking

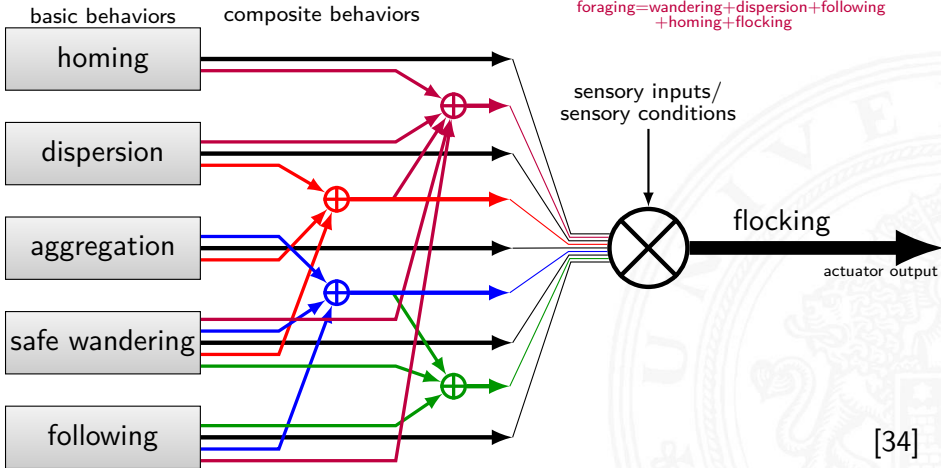

[34]

SENSORS

BEHAVIORS

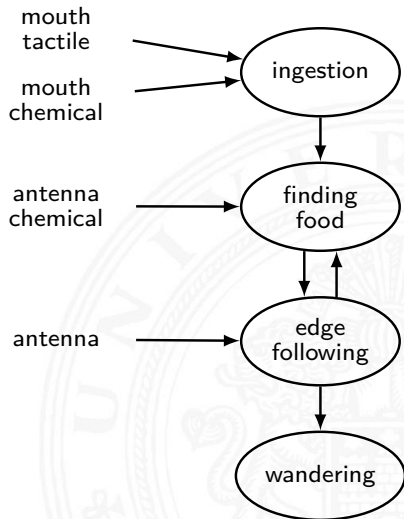
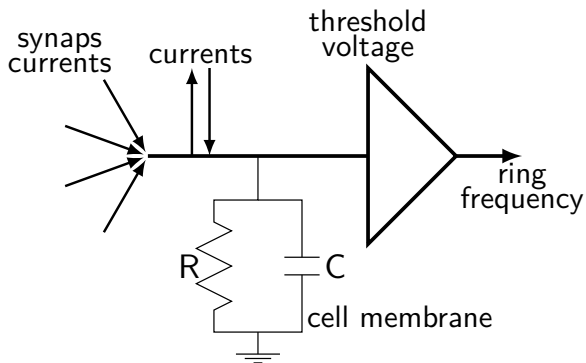



Control and information flow in artificial fish

Perception sensors, focuser, filter

Behaviors behavior routines

Brain/mind habits, intention generator

Learning optimization

Motor motor controllers, actuators/muscles

Control Architecture of a Fish (cont.)

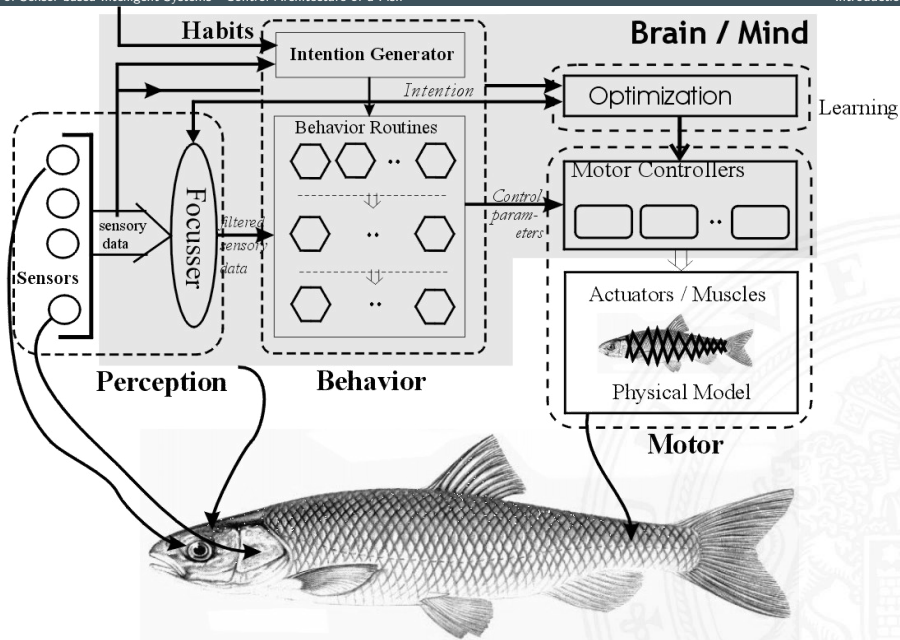

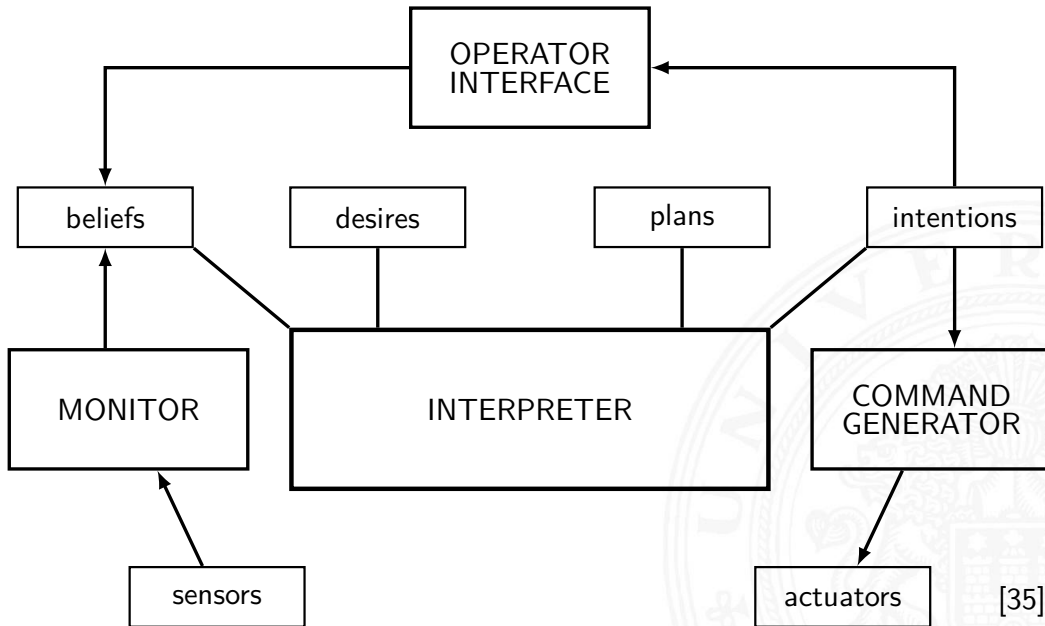

[35]



Real-Time Control System (RCS)

- ▶ RCS reference model is an architecture for intelligent systems.
- ▶ Processing modes are organized such that the BG (Behavior Generation) modules form a command tree.
- ▶ Information in the knowledge database is shared between WM (World Model) modules in nodes within the same subtree.

[36]

Examples of functional characteristics of the BG and WM modules:

Hierarchy (cont.)

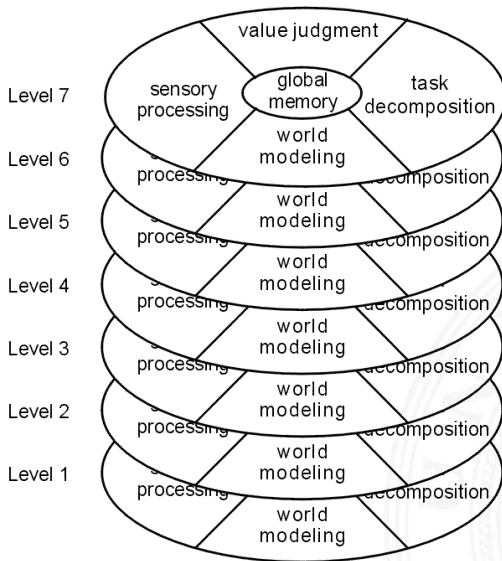

Hierarchy (cont.)

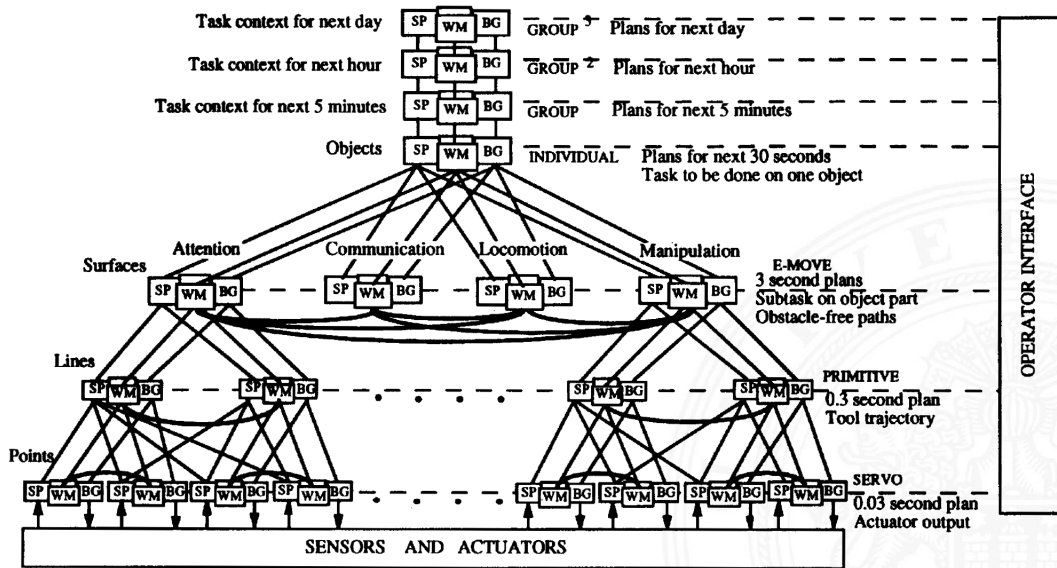

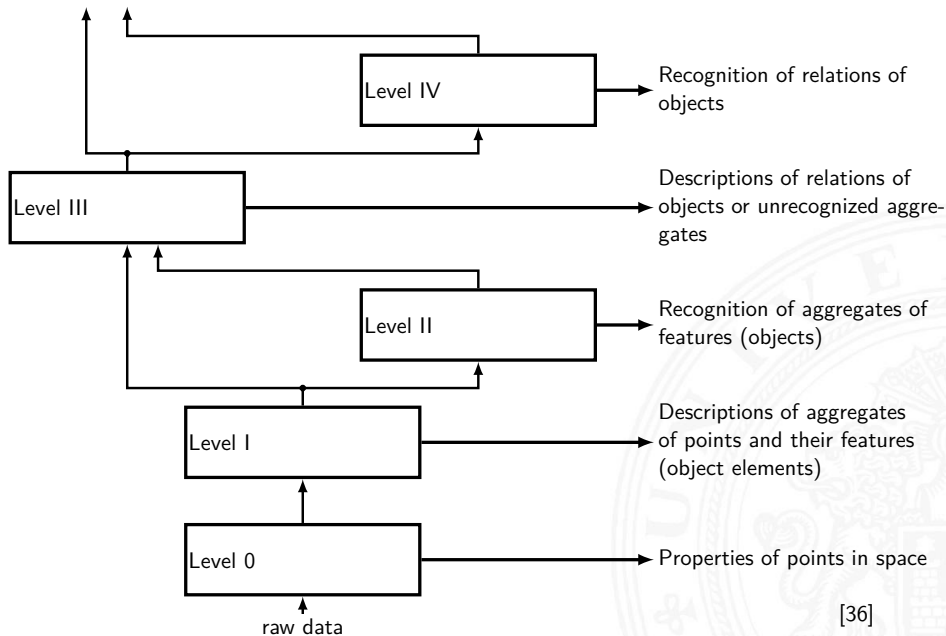

[36]

An Architecture for Learning Robots

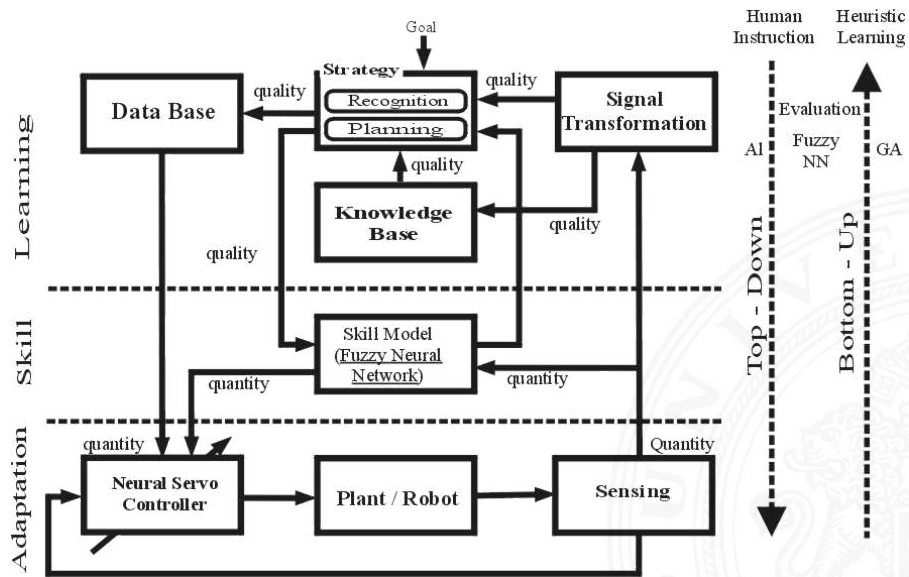

[37]

RACE

Robustness by Autonomous Competence Enhancement

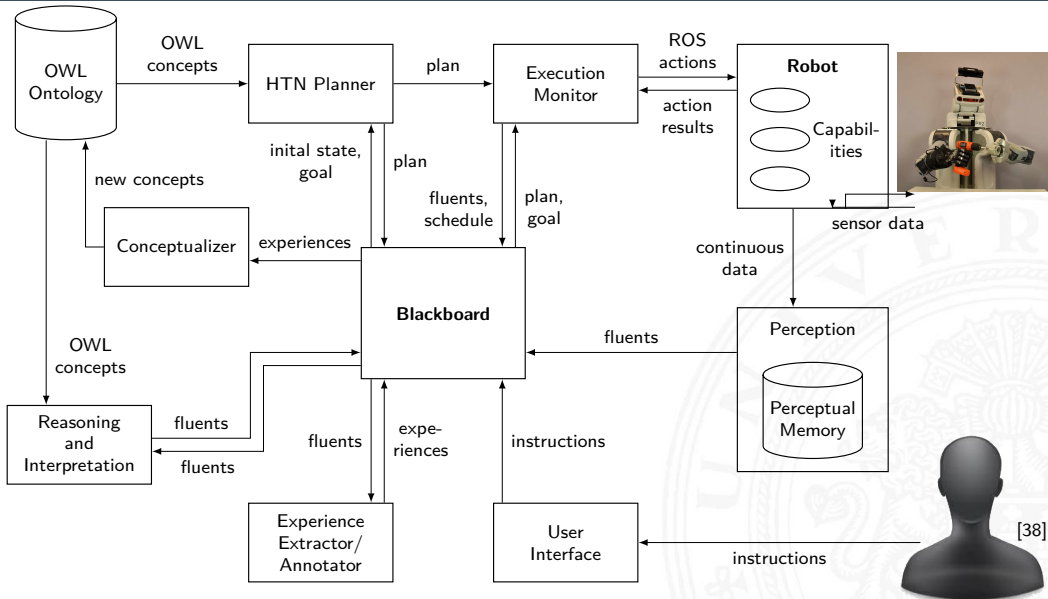



- [1] G.-Z. Yang, R. J. Full, N. Jacobstein, P. Fischer, J. Bellingham, H. Choset, H. Christensen, P. Dario, B. J. Nelson, and R. Taylor, “Ten robotics technologies of the year,” 2019.
- [2] J. K. Yim, E. K. Wang, and R. S. Fearing, “Drift-free roll and pitch estimation for high-acceleration hopping,” in *2019 International Conference on Robotics and Automation (ICRA)*, pp. 8986–8992, IEEE, 2019.
- [3] J. F. Engelberger, *Robotics in service*. MIT Press, 1989.
- [4] K. Fu, R. González, and C. Lee, *Robotics: Control, Sensing, Vision, and Intelligence*. McGraw-Hill series in CAD/CAM robotics and computer vision, McGraw-Hill, 1987.
- [5] R. Paul, *Robot Manipulators: Mathematics, Programming, and Control: the Computer Control of Robot Manipulators*. Artificial Intelligence Series, MIT Press, 1981.
- [6] J. Craig, *Introduction to Robotics: Pearson New International Edition: Mechanics and Control*. Always learning, Pearson Education, Limited, 2013.



- [7] T. Flash and N. Hogan, "The coordination of arm movements: an experimentally confirmed mathematical model," *Journal of neuroscience*, vol. 5, no. 7, pp. 1688–1703, 1985.
- [8] T. Kröger and F. M. Wahl, "Online trajectory generation: Basic concepts for instantaneous reactions to unforeseen events," *IEEE Transactions on Robotics*, vol. 26, no. 1, pp. 94–111, 2009.
- [9] W. Böhm, G. Farin, and J. Kahmann, "A Survey of Curve and Surface Methods in CAGD," *Comput. Aided Geom. Des.*, vol. 1, pp. 1–60, July 1984.
- [10] J. Zhang and A. Knoll, "Constructing Fuzzy Controllers with B-spline Models - Principles and Applications," *International Journal of Intelligent Systems*, vol. 13, no. 2-3, pp. 257–285, 1998.
- [11] M. Eck and H. Hoppe, "Automatic Reconstruction of B-spline Surfaces of Arbitrary Topological Type," in *Proceedings of the 23rd Annual Conference on Computer Graphics and Interactive Techniques, SIGGRAPH '96*, (New York, NY, USA), pp. 325–334, ACM, 1996.



- [12] A. Cowley, W. Marshall, B. Cohen, and C. J. Taylor, "Depth space collision detection for motion planning," 2013.
- [13] Hornung, Armin and Wurm, Kai M. and Bennewitz, Maren and Stachniss, Cyrill and Burgard, Wolfram, "OctoMap: an efficient probabilistic 3D mapping framework based on octrees," *Autonomous Robots*, vol. 34, pp. 189–206, 2013.
- [14] D. Berenson, S. S. Srinivasa, D. Ferguson, and J. J. Kuffner, "Manipulation planning on constraint manifolds," in *2009 IEEE International Conference on Robotics and Automation*, pp. 625–632, 2009.
- [15] S. Karaman and E. Frazzoli, "Sampling-based algorithms for optimal motion planning," *The International Journal of Robotics Research*, vol. 30, no. 7, pp. 846–894, 2011.
- [16] O. Khatib, "The Potential Field Approach and Operational Space Formulation in Robot Control," in *Adaptive and Learning Systems*, pp. 367–377, Springer, 1986.
- [17] L. E. Kavraki, P. Svestka, J. Latombe, and M. H. Overmars, "Probabilistic roadmaps for path planning in high-dimensional configuration spaces," *IEEE Transactions on Robotics and Automation*, vol. 12, no. 4, pp. 566–580, 1996.



- [18] J. Kuffner and S. LaValle, "RRT-Connect: An Efficient Approach to Single-Query Path Planning.," vol. 2, pp. 995–1001, 01 2000.
- [19] J. Starek, J. Gómez, E. Schmerling, L. Janson, L. Moreno, and M. Pavone, "An asymptotically-optimal sampling-based algorithm for bi-directional motion planning," *Proceedings of the ... IEEE/RSJ International Conference on Intelligent Robots and Systems. IEEE/RSJ International Conference on Intelligent Robots and Systems*, vol. 2015, 07 2015.
- [20] D. Hsu, J. . Latombe, and R. Motwani, "Path planning in expansive configuration spaces," in *Proceedings of International Conference on Robotics and Automation*, vol. 3, pp. 2719–2726 vol.3, 1997.
- [21] A. H. Qureshi, A. Simeonov, M. J. Bency, and M. C. Yip, "Motion planning networks," in *2019 International Conference on Robotics and Automation (ICRA)*, pp. 2118–2124, IEEE, 2019.
- [22] J. Schulman, J. Ho, A. Lee, I. Awwal, H. Bradlow, and P. Abbeel, "Finding locally optimal, collision-free trajectories with sequential convex optimization," in *in Proc. Robotics: Science and Systems*, 2013.



- [23] A. T. Miller and P. K. Allen, “Graspit! a versatile simulator for robotic grasping,” *IEEE Robotics Automation Magazine*, vol. 11, no. 4, pp. 110–122, 2004.
- [24] A. ten Pas, M. Gualtieri, K. Saenko, and R. Platt, “Grasp pose detection in point clouds,” *The International Journal of Robotics Research*, vol. 36, no. 13-14, pp. 1455–1473, 2017.
- [25] L. P. Kaelbling and T. Lozano-Pérez, “Hierarchical task and motion planning in the now,” in *2011 IEEE International Conference on Robotics and Automation*, pp. 1470–1477, 2011.
- [26] N. T. Dantam, Z. K. Kingston, S. Chaudhuri, and L. E. Kavraki, “Incremental task and motion planning: A constraint-based approach.,” in *Robotics: Science and Systems*, pp. 1–6, 2016.
- [27] J. Ferrer-Mestres, G. Francès, and H. Geffner, “Combined task and motion planning as classical ai planning,” *arXiv preprint arXiv:1706.06927*, 2017.
- [28] M. Görner, R. Haschke, H. Ritter, and J. Zhang, “Movelt! Task Constructor for Task-Level Motion Planning,” in *IEEE International Conference on Robotics and Automation (ICRA)*, 2019.



- [29] K. Hauser and J.-C. Latombe, "Multi-modal motion planning in non-expansive spaces," *The International Journal of Robotics Research*, vol. 29, no. 7, pp. 897–915, 2010.
- [30] B. Siciliano and O. Khatib, *Springer handbook of robotics*. Springer, 2016.
- [31] P. Sermanet, C. Lynch, Y. Chebotar, J. Hsu, E. Jang, S. Schaal, S. Levine, and G. Brain, "Time-contrastive networks: Self-supervised learning from video," in *2018 IEEE International Conference on Robotics and Automation (ICRA)*, pp. 1134–1141, IEEE, 2018.
- [32] C. Finn, P. Abbeel, and S. Levine, "Model-agnostic meta-learning for fast adaptation of deep networks," *arXiv preprint arXiv:1703.03400*, 2017.
- [33] R. Brooks, "A robust layered control system for a mobile robot," *Robotics and Automation, IEEE Journal of*, vol. 2, pp. 14–23, Mar 1986.
- [34] M. J. Mataric, "Interaction and intelligent behavior.," tech. rep., DTIC Document, 1994.



- [35] M. P. Georgeff and A. L. Lansky, "Reactive reasoning and planning.," in *AAAI*, vol. 87, pp. 677–682, 1987.
- [36] J. S. Albus, "The nist real-time control system (rcs): an approach to intelligent systems research," *Journal of Experimental & Theoretical Artificial Intelligence*, vol. 9, no. 2-3, pp. 157–174, 1997.
- [37] T. Fukuda and T. Shibata, "Hierarchical intelligent control for robotic motion by using fuzzy, artificial intelligence, and neural network," in *Neural Networks, 1992. IJCNN., International Joint Conference on*, vol. 1, pp. 269–274 vol.1, Jun 1992.
- [38] L. Einig, *Hierarchical Plan Generation and Selection for Shortest Plans based on Experienced Execution Duration*.
Master thesis, Universität Hamburg, 2015.
- [39] J. Craig, *Introduction to Robotics: Mechanics & Control. Solutions Manual*.
Addison-Wesley Pub. Co., 1986.



- [40] H. Siegert and S. Bocionek, *Robotik: Programmierung intelligenter Roboter: Programmierung intelligenter Roboter*. Springer-Lehrbuch, Springer Berlin Heidelberg, 2013.
- [41] R. Schilling, *Fundamentals of robotics: analysis and control*. Prentice Hall, 1990.
- [42] T. Yoshikawa, *Foundations of Robotics: Analysis and Control*. Cambridge, MA, USA: MIT Press, 1990.
- [43] M. Spong, *Robot Dynamics And Control*. Wiley India Pvt. Limited, 2008.

